

# 2025

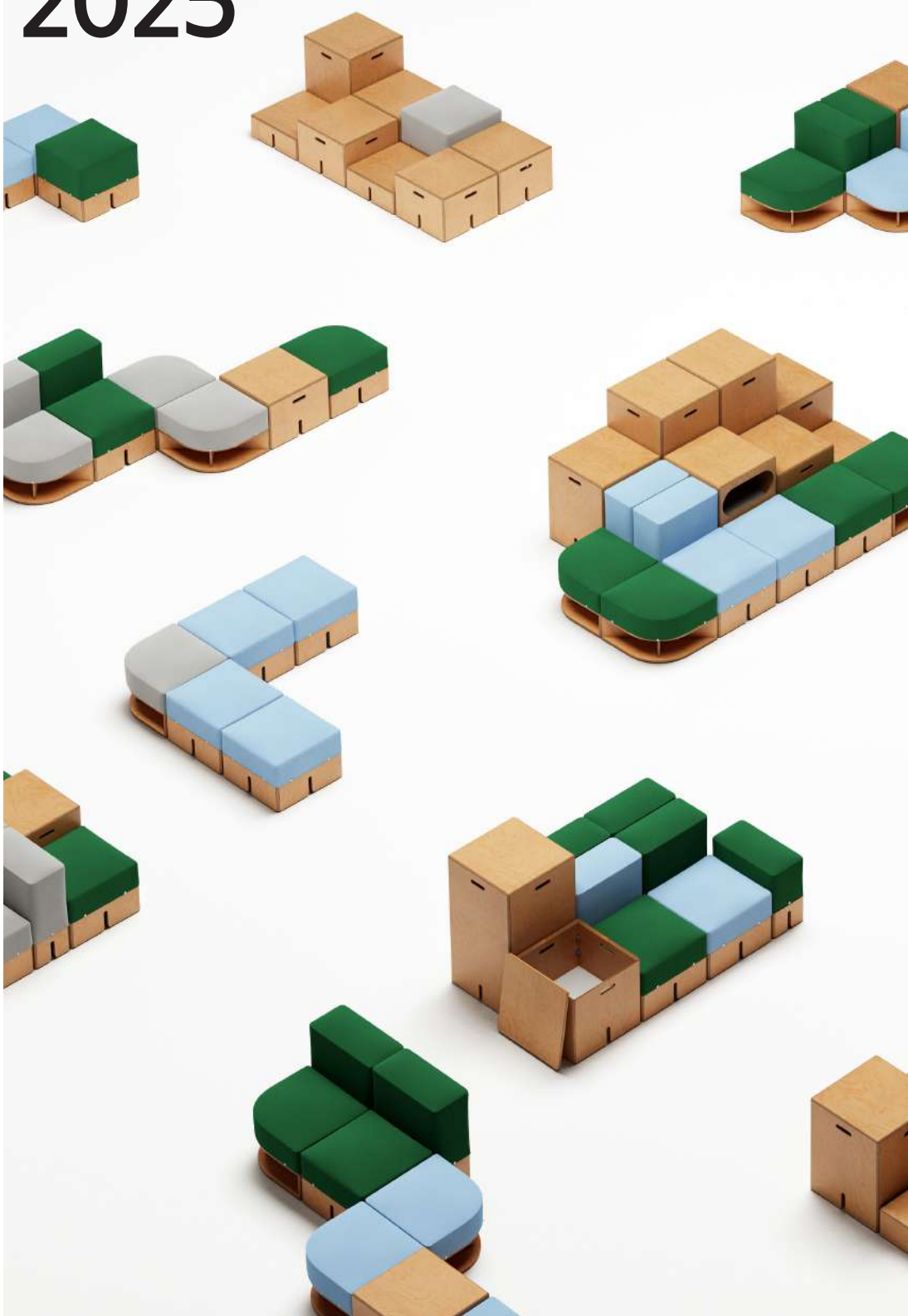

**KEIGIO DESIGN S.L. - Catalog**

**CONFIDENTIAL AND PROPERTY**

This catalog is the property of KEIGIO DESIGN SL. Imitation or printing of its illustrations and partial or total configuration is prohibited without express permission from KEIGIO®. The company reserves the right to modify its design and structure. The company is not responsible for errors made by third parties in translations or printing.

**The following catalog is created by the technical and design team of KEIGIO®.**



We would like to remind our dear customers that a .pdf version of the 2025 CATALOG is available on our website [www.keigio.com](http://www.keigio.com). We invite you to view it digitally or download it. This catalog is printed on FSC paper.

FSC stands for Forest Stewardship Council, an organization dedicated to promoting sustainable forestry practices worldwide. Let's take care of our planet and be sustainable.

**INDEX**

ABOUT KEIGIO®	4 - 7
36x36 SYSTEM	10 - 21
<b>54x54 SYSTEM</b>	<b>22 - 45</b>
LOCKER	34 - 39
DESK	40 - 45
PONG	46 - 55
SHELF SYSTEM	56 - 63
TABLE	64 - 71
CHAIR	72 - 79
STOOLS	80 - 85
LAMP SYSTEM	86 - 89
SUSTAINABILITY	90 - 91



Giovanni Bruni, Designer & Founder

In tune with the world of underground art, **KEIGIO®** aims to connect with people who are curious about new concepts. **KEIGIO®** is a brand that wants to make an impact on those who love to grow by constantly questioning their surroundings and are open to be amazed.

**KEIGIO®** offers an alternative to the tastes of the mainstream modular furniture market.

## ABOUT US

---

**KEIGIO®** is a high quality modular furniture brand offering sofas, shelves, lamp systems, chairs and tables with a retro-futuristic industrial design, always adapting to any space in shape and dimension.

---

**KEIGIO®** was born as a personal project by the Italian designer Giovanni Bruni.

In 2015 he developed his first modular structure. Then, he founded **KEIGIO®** and opened his interior design studio in an industrial loft in Barcelona, constantly looking for new modular solutions for different spaces.

The name of the **KEIGIO®** brand derives from the Japanese word 形状 *Keijō* which means *the shape of a physical object located in a space*. It has been chosen by the founder due to his great passion for the country of the rising sun. Simplicity, craftsmanship and premium materials characterize Japanese design and above all, projects that present clean lines, minimalist furniture and natural elements.

Our vision is to generate the instruments for everyone to become their own interior designer, creating micro-architectures easily reassemblable and adaptable to any space and need.

## OUR CONCEPT

**KEIGIO®** takes up the concept of “Gamification” proposing typical game dynamics and applying them to interior design in order to enhance motivation to solve problems such as adaptation to a world in global movement where home and job may suddenly change. The modular elements, easily transportable and reassemblable, become a practical solution giving the user the freedom to create their interiors.

## PHILOSOPHY

When we create our products, we focus both on high quality and craftsmanship for maximum durability and also the impact they will have on the environment. We make sure that all the materials are traceable as well as consider the sustainability of the production processes.

All furniture is modular, which means that each piece can be customized in materials, dimensions and finishes.

## THE ADVANTAGES OF MODULAR FURNITURE

The world of **KEIGIO®** modular furniture offers numerous advantages and exciting opportunities for both designers and consumers.

- 1. FLEXIBILITY:** **KEIGIO®** modular furniture allows for greater flexibility in space design. Since the pieces are designed to be configured and combined in different ways, you can easily adapt your furniture to your needs and the dimensions of your space.
- 2. ADAPTABILITY:** Particularly suited to evolving environments, such as expanding office spaces, growing residences, or temporary housing. By using our **KEIGIO®** furniture, you can add or remove modules based on changing needs.
- 3. CREATIVITY:** Modular furniture offers many possibilities for creative expression and personalized design. With **KEIGIO®**, you can create unique configurations that reflect your style and meet your functional needs.
- 4. SPACE OPTIMIZATION:** **KEIGIO®** furniture is ideal for maximizing available space, especially in smaller spaces. It can contribute to maximizing space utilization efficiency.
- 5. DURABILITY:** The ability to replace or upgrade specific parts of modular furniture can help reduce waste and environmental impact. Additionally, some companies produce modular furniture using sustainable materials. High-quality **KEIGIO®** modular furniture tends to last over time, making it a good long-term investment.
- 6. CUSTOMIZATION:** **KEIGIO®** offers customization options, allowing customers to choose materials, colors, and finishes that match their preferences.
- 7. EASY TRANSPORT AND ASSEMBLY:** **KEIGIO®** modular furniture is ingeniously designed to be easily transported and assembled, simplifying the delivery and assembly process compared to non-modular furniture alternatives.

In general, **KEIGIO®** modular furniture is an interesting choice for those seeking versatile and customizable solutions for their spaces. Always pay attention to the quality of materials and design, as this will influence the longevity and appearance of the furniture over time.



All our products are available in a pCon Planner-compatible version. You can download all our models directly from our page Downloads on the website. Alternatively, you can send us a configuration, and we will provide it in the appropriate extension for direct import into pCon Planner.

If you are viewing the online version of this pricelist, you can click icon "pCon Ready" or on the link below.

<https://www.keigio.com/downloads>

#FLEX-OFFICE

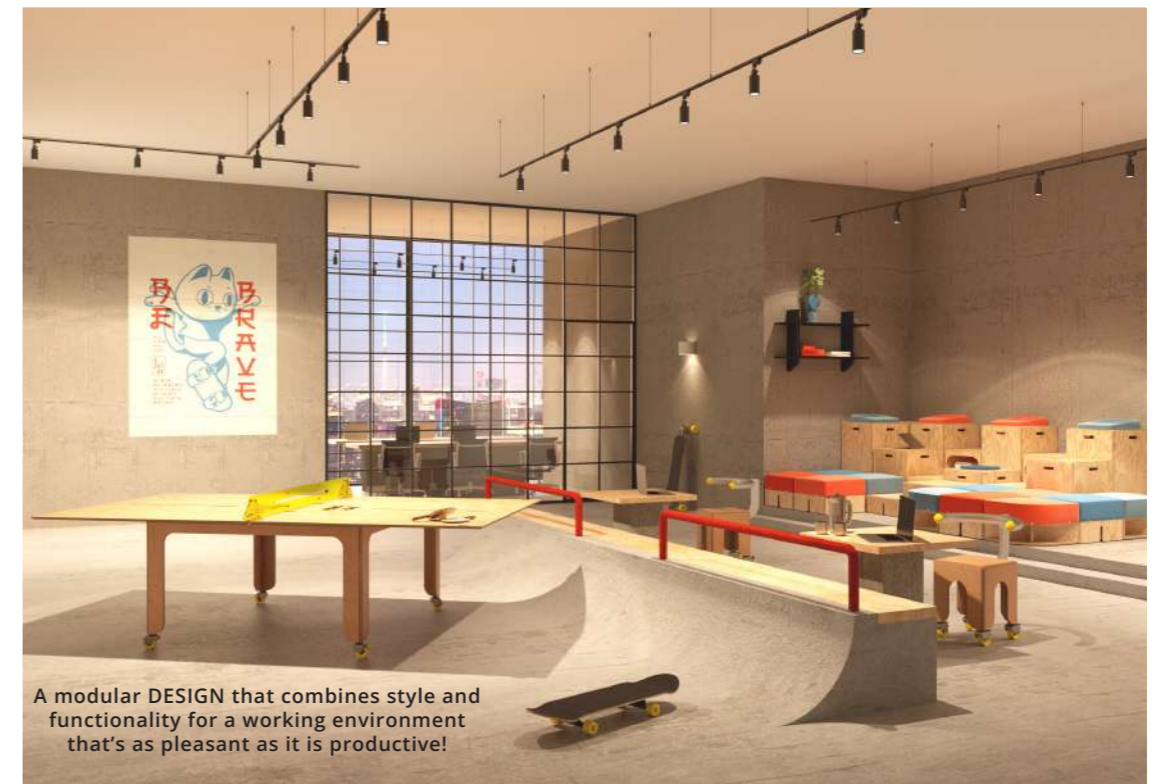

A modular DESIGN that combines style and functionality for a working environment that's as pleasant as it is productive!

# 36x36 SYSTEM

The **KEIGIO® 36x36** is our first project that we are very proud of. It is a modular system consisting of interchangeable modules, all with a 36x36 centimeter base.

Without a doubt, the **KEIGIO® 36x36** is the sofa system with the smallest modules on the market! The different modules vary in height and functionality.

There are **WOODEN** modules, perfect as support surfaces and for storing objects inside.

The **SOFA PUFF** modules come in three different heights and can be used as seats (h36), armrests (h48), and backrests (h64).

The **SOFA PUFF** modules are made using comfortable foams of different densities and 6 cm of memory foam on top of everyone.

The **KEIGIO® 36x36** is completed with a set of **CUSHIONS**. Fabrics, colors, as well as wooden materials can be chosen from a wide range of proposals or customised, if required.

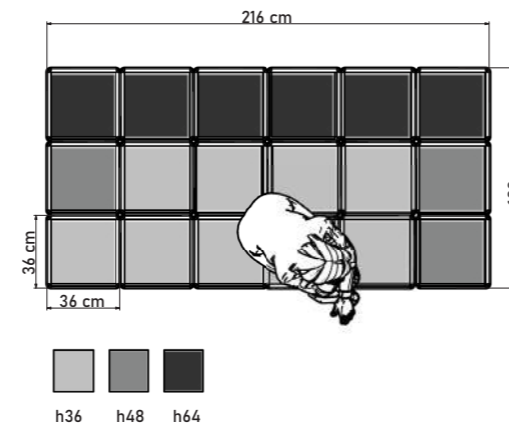

# 54X54 SYSTEM

**KEIGIO® 54x54** is our most comprehensive and innovative system. All modules are interchangeable and have a 54x54 centimeter base.

We designed this system to fulfill two different needs: to create comfortable sofas and to establish chill-out spaces at various heights, like bleachers in trendy offices.

With **KEIGIO® 54x54** we have created something unique, a new concept that combines the classic office furniture with home furniture. It is extremely **functional & flexible**.

The **WOODEN** modules can have 5 different heights and two different systems for storing items such as laptops, notebooks, or cushions.

Then there are the **SOFA PUFF** modules, incredibly comfortable with their 6 cm of memory foam on top.

The **KEIGIO® 54x54** is completed with a movable **SIDE TABLE** and the set of **CUSHIONS**. All of them can be customized in terms of colors, finishes, and materials.

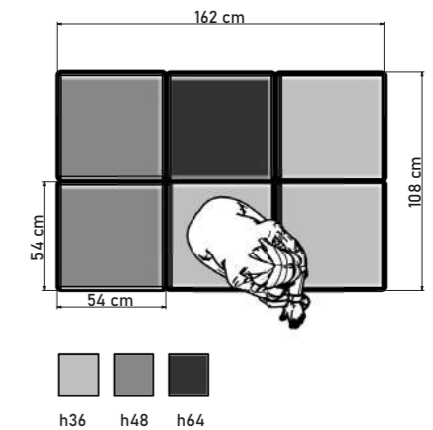

**KEIGIO® 36X36**



# 36x36 MODULAR SYSTEM

The **KEIGIO® 36x36 System** offers **9 modules, many colors and 1000 ways to create a comfortable and personalized sofa.**

The **KEIGIO® 36X36** modular system is essentially composed of 2 types of elements with the same dimensions that make them perfectly interchangeable: the comfortable **SOFA PUFF** seats and the **WOODEN** end table - box.

The **SOFA PUFF** modules can be transformed into **FLOOR CUSHIONS** by removing the wooden plinth and replacing it with a special cover with an eco-leather base.

**FLOOR CUSHIONS** are soft and practical elements to furnish your children's bedroom floor or any other space you wish.

The **KEIGIO® 36x36** System is completed with two **CUSHIONS**, one rectangular and one triangular with removable, washable covers.

## KEIGIO® 36X36



**INTERIOR DESIGN STUDIO**

**The Loft** - Poble Nou, Barcelona.



## 1. SOFA PUFF

The **SOFA PUFF** elements have a base of 36 x 36 centimeters and 3 possible heights of 36, 48 and 64 centimeters.  
The **SOFA PUFF** modules all have a top layer of 6 cm of **viscoelastics**.

## 2. WOODEN

The **WOODEN** elements have a base of 36 x 36 centimeters and 3 possible heights of 36, 48 and 64 centimeters.

All the modules are built with strictly FSC wood.  
They are perfect as **end table** or **storage box**.



## 3. FLOOR CUSHION

The **FLOOR CUSHION** are elements derived directly from the **SOFA PUFF** modules but do not have a rigid base.  
They stand directly on the floor on a black eco-leather base.

Unlike the other **KEIGIO® 36x36** modules, they are not intended to join together but are particularly suitable as furniture or play elements for children.

## 4. CUSHIONS

The **CUSHION** elements are specifically designed to integrate with the **KEIGIO® 36x36** System.  
Triangular and Rectangular shapes, 8 colors and 1000 ways to make your sofa even more comfortable and original.

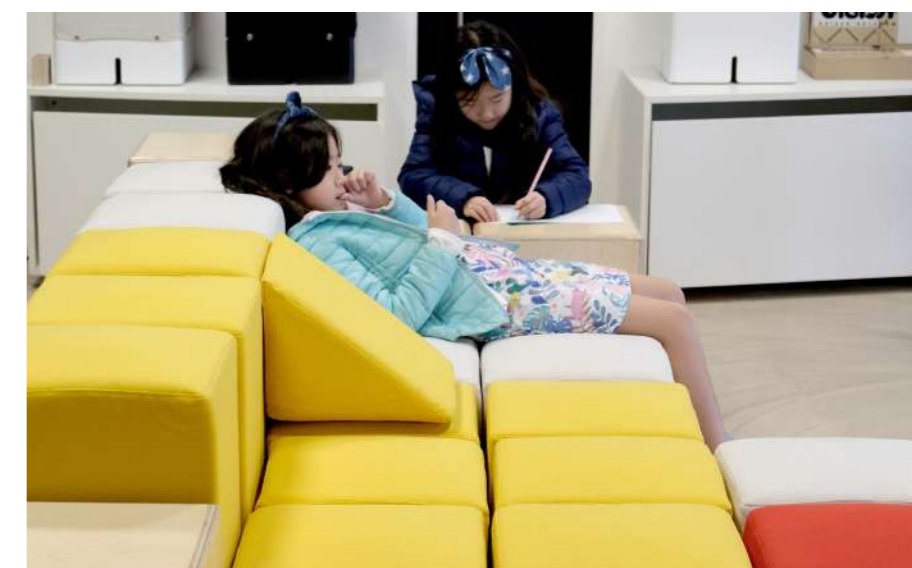





**36x36 MODULES**

- SOFA PUFF**  
h36, h48, h64
- WOODEN**  
h36, h48, h64
- FLOOR CUSHION**  
h24, h36, h52
- CUSHIONS**  
Rectangular - Triangular

**ASSEMBLY**

**With the help of a third H-shaped element made of solid wood we connect the KEIGIO® System Modules.**

The **KEIGIO® 36x36** and **KEIGIO® 54x54** System utilize a **solid birch** wood element with a unique geometry that enables the seamless connection of various modules. This design allows for easy insertion or removal of individual modules within the sofa system, regardless of their position.

For instance, if you wish to change the color of a cushion cover, simply pull the desired puff upwards to detach it from the sofa system. This effortless removal allows for convenient replacement of the cover, and once done, you can easily insert the puff back into place using the same process. This user-friendly feature ensures hassle-free customization and flexibility for your modular system.

**H-SHAPED JOINT**

H-shaped joint elements in solid beech wood with magnets to help during assembly.

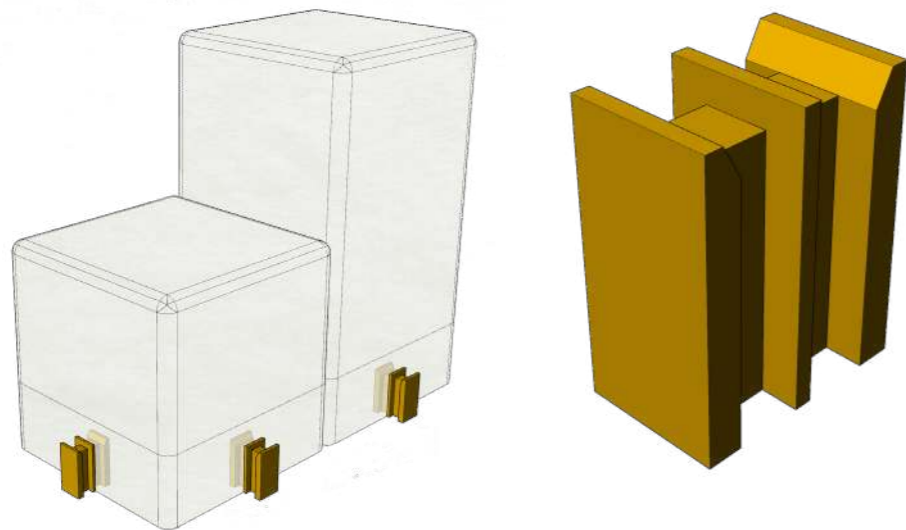



## DELTA AWARDS

The Delta Awards aim to celebrate excellence in design and emphasize its importance as a prime tool for creating wealth in an industrial economy, as well as highlighting its role as an expression of our culture.



Bronze Delta  
ADI Awards 2020

# COLORWAY

LASER N

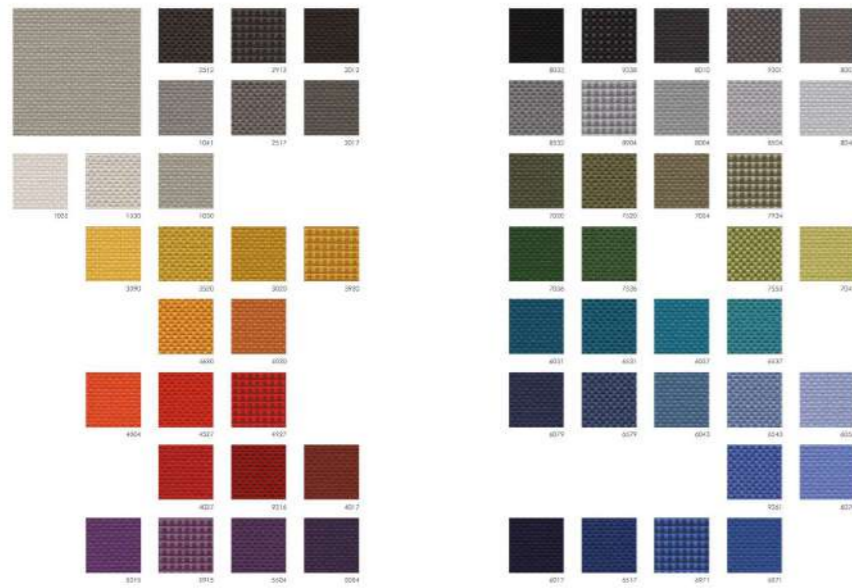

## FIDIVI\*



### LASER N

Compact fabric in united, two-coloured and three-coloured types. 58 colorways.

480 g/ml - 340 g/m<sup>2</sup>

100% Polyester Trevira CS

## Gabriel\*



### TONAL

Tonal is made from recycled post-consumer polyester and has an excellent environmental profile.

99% post-consumer recycled polyester / 1% polyester

### CURA

Cura is a multi-purpose, two-coloured upholstery fabric made from 98% post-consumer recycled polyester.

98% post-consumer recycled polyester / 2% polyester

TONAL



CURA

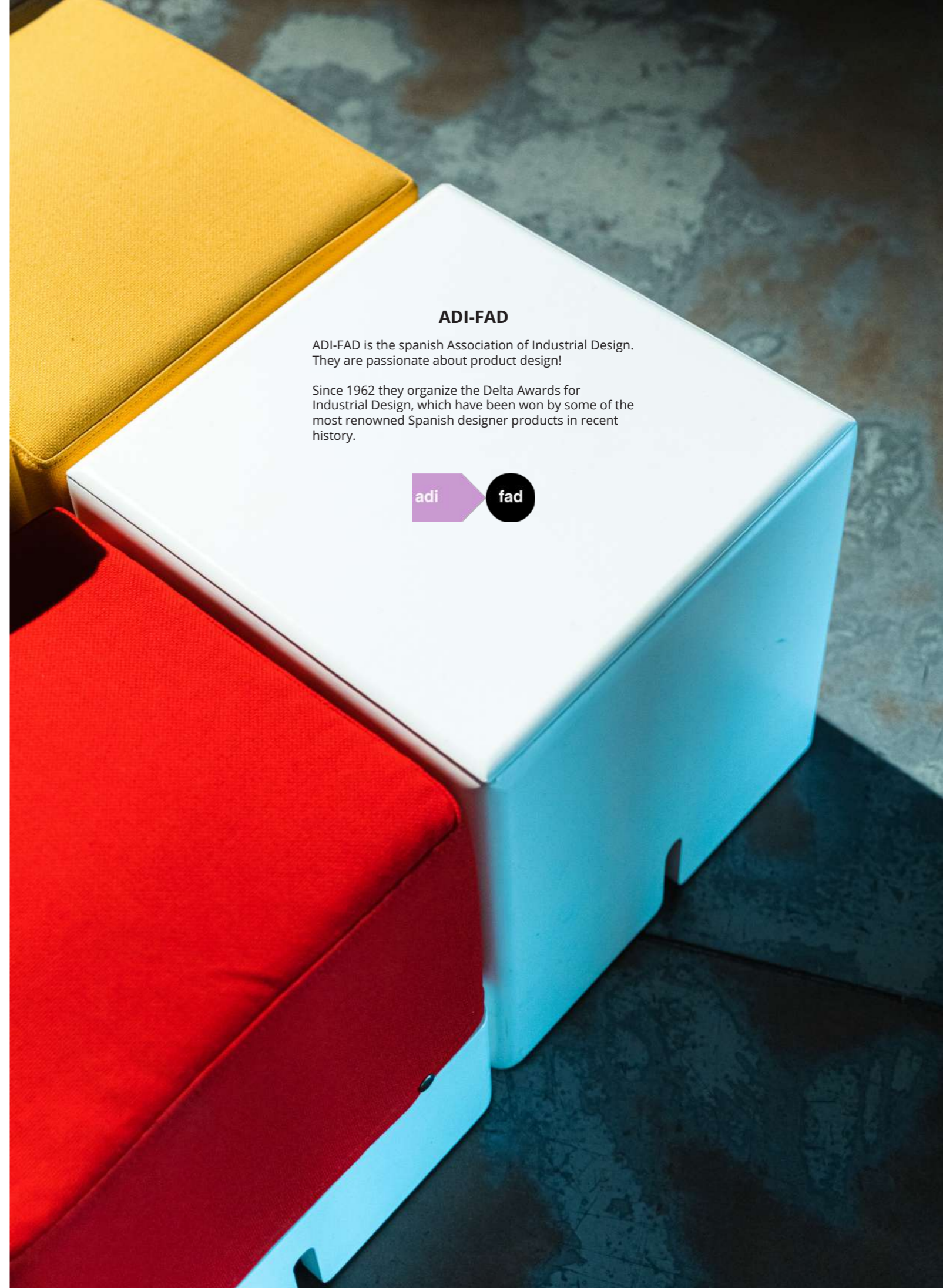
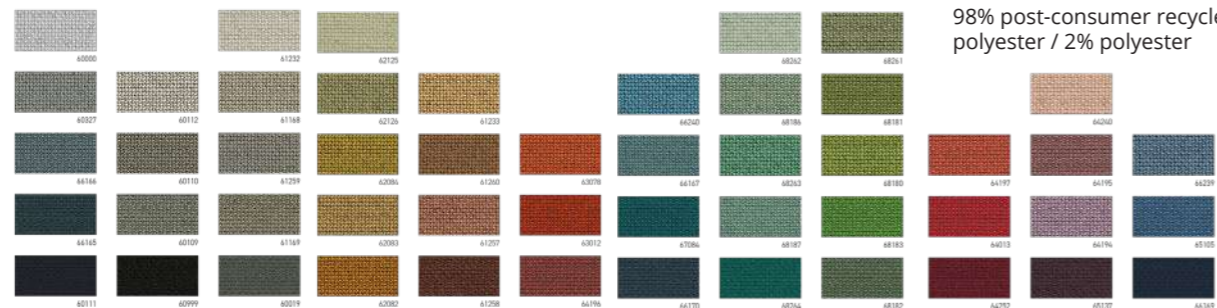

## ADI-FAD

ADI-FAD is the spanish Association of Industrial Design. They are passionate about product design!

Since 1962 they organize the Delta Awards for Industrial Design, which have been won by some of the most renowned Spanish designer products in recent history.



# KEIGIO® 54x54



# KEIGIO® 54x54



#MODULARSYSTEM #MODULARSOFA #BLEACHERS #PUBLICSEATINGSYSTEM

## 54x54 Modular System

The modular KEIGIO® 54x54 System is easily reconfigurable to create seating areas, sofa systems, auditorium spaces or collaboration points with an incredible flexibility from chillout space, to meditation, to playground.

The KEIGIO® 54x54 System embraces sustainability by utilizing FSC certified wood materials. With finishes available in natural Birch, natural Pine, white, or black lacquered.

The elements are durable and robust, the KEIGIO® 54x54 System is suitable for various locations such as bars, restaurants, offices, commercial spaces, and homes. Its versatility ensures a seamless integration into any environment.

The SOFA PUFF modules and upholstered CUSHION pads are meticulously crafted to order, offering a wide range of fabric options, colors, and patterns. The foams and fabrics used could be fire-resistant and fully certified for contract use, ensuring safety and compliance with regulations.

The SOFA PUFF modules all have a top layer of 6 cm of viscoelastics.

### 54x54 MODULES

**WOODEN**  
h36, h48, h64, h92

**SPECIAL WOODEN**  
h48 HOLE, h64 STORAGE

**SOFA PUFF**  
h36, h48

**SPECIAL PUFF**  
h36 ROUNDED, h48 ARMREST,  
h64 BACKREST

**CUSHIONS**  
50X50, 24X50

**SIDE TABLE**



MODULAR OFFICE SYSTEM 54X54

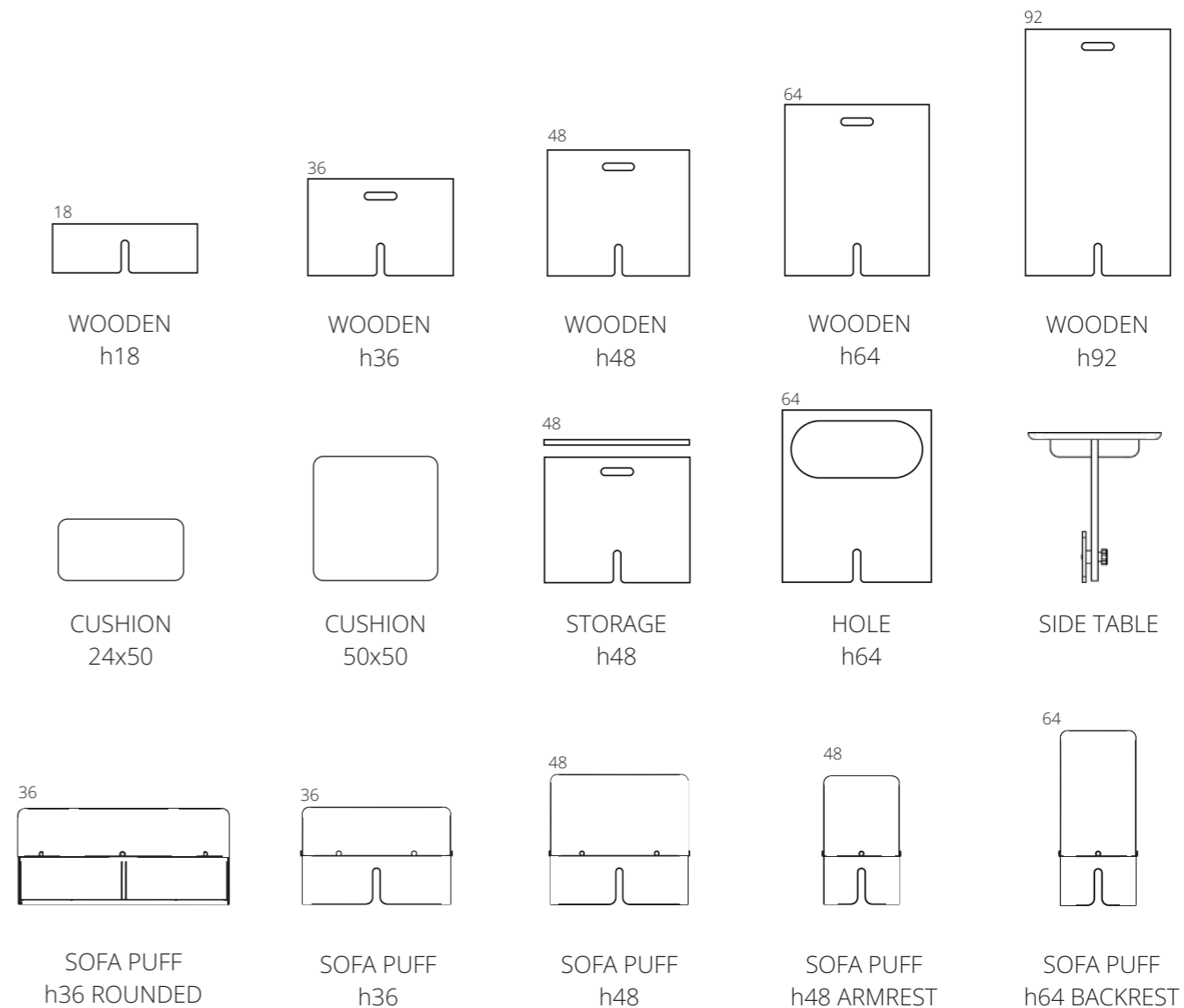
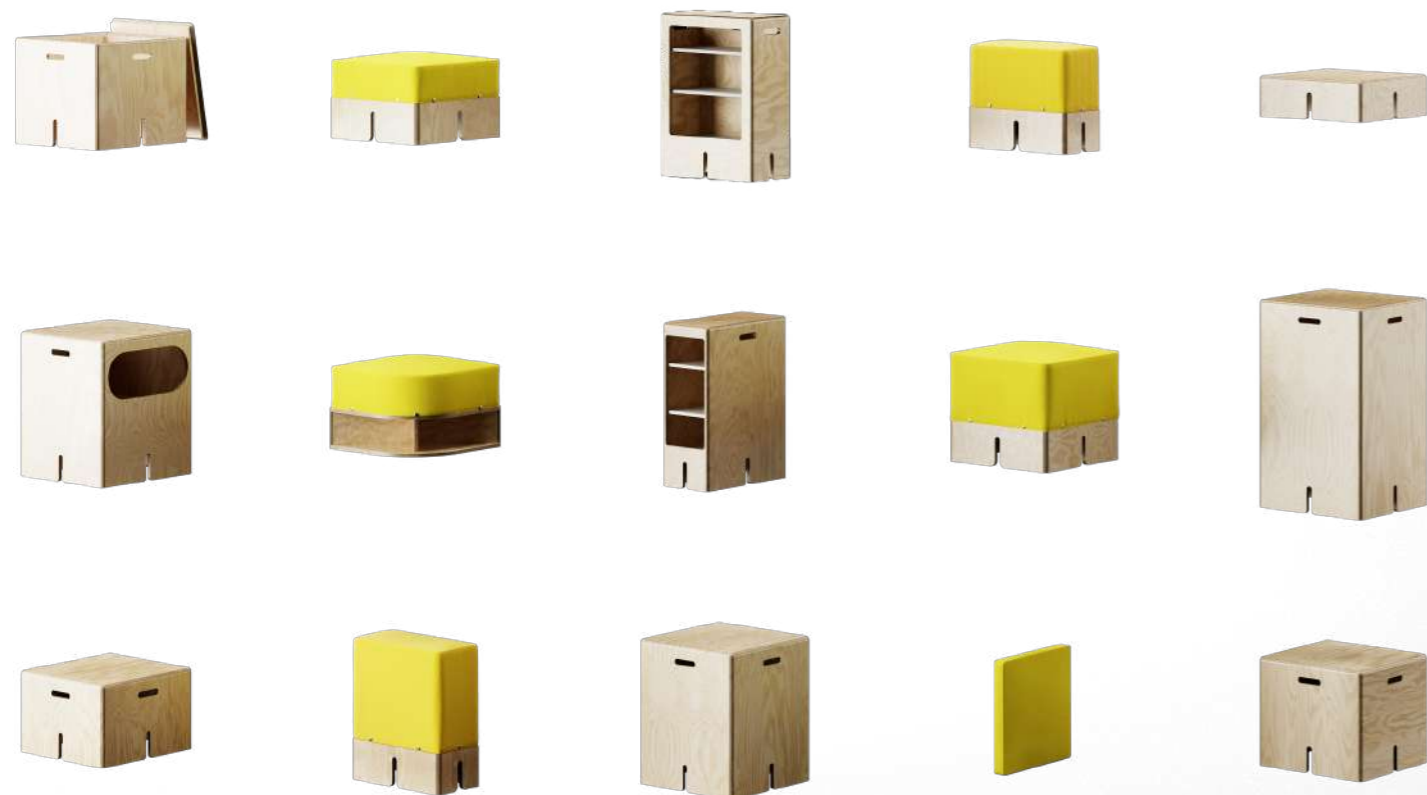

## SIDE TABLE

The **SIDE TABLE**, is a unique element, it can be hung in the handle holes, transforming every wooden module into a workstation or a standalone table-chair.

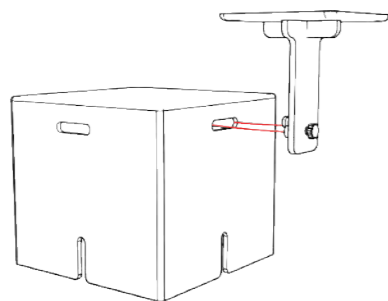

## ASSEMBLY

H-shaped joint elements in solid birch wood with magnets to help during assembly. Each module can be inserted or removed regardless of their position inside the sofa system.

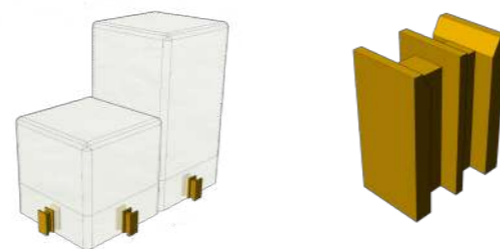

## KEIGIO® 54x54 WOODEN Modules

The **KEIGIO WOODEN** Modules set consists distinct variants. This includes 5 different heights: **h18, h36, h48, h64, h92**.

There are also special modules like **h48 HOLE** and **h64 STORAGE**, designed for storage books, laptops or small objects.

## KEIGIO® 54x54 SOFA PUFF Modules

The **SOFA PUFF** Modules are available in **h36, h48** and the special ones: **h36 ROUNDED, h48 ARMREST**, and **h64 BACKREST**.

All **SOFA PUFF** Modules are crafted and designed for **Contract. Certified textiles**, and **FSC Certified wood**.

## KEIGIO® 54x54 CUSHIONS

The **CUSHIONS** are offered in two size options: **50x50** cm and **24x50** cm.

The **50x50** version provides complete coverage of the seat surface, while the **24x50** is specifically designed to leave a gap to allow easy passage of people and their feet.

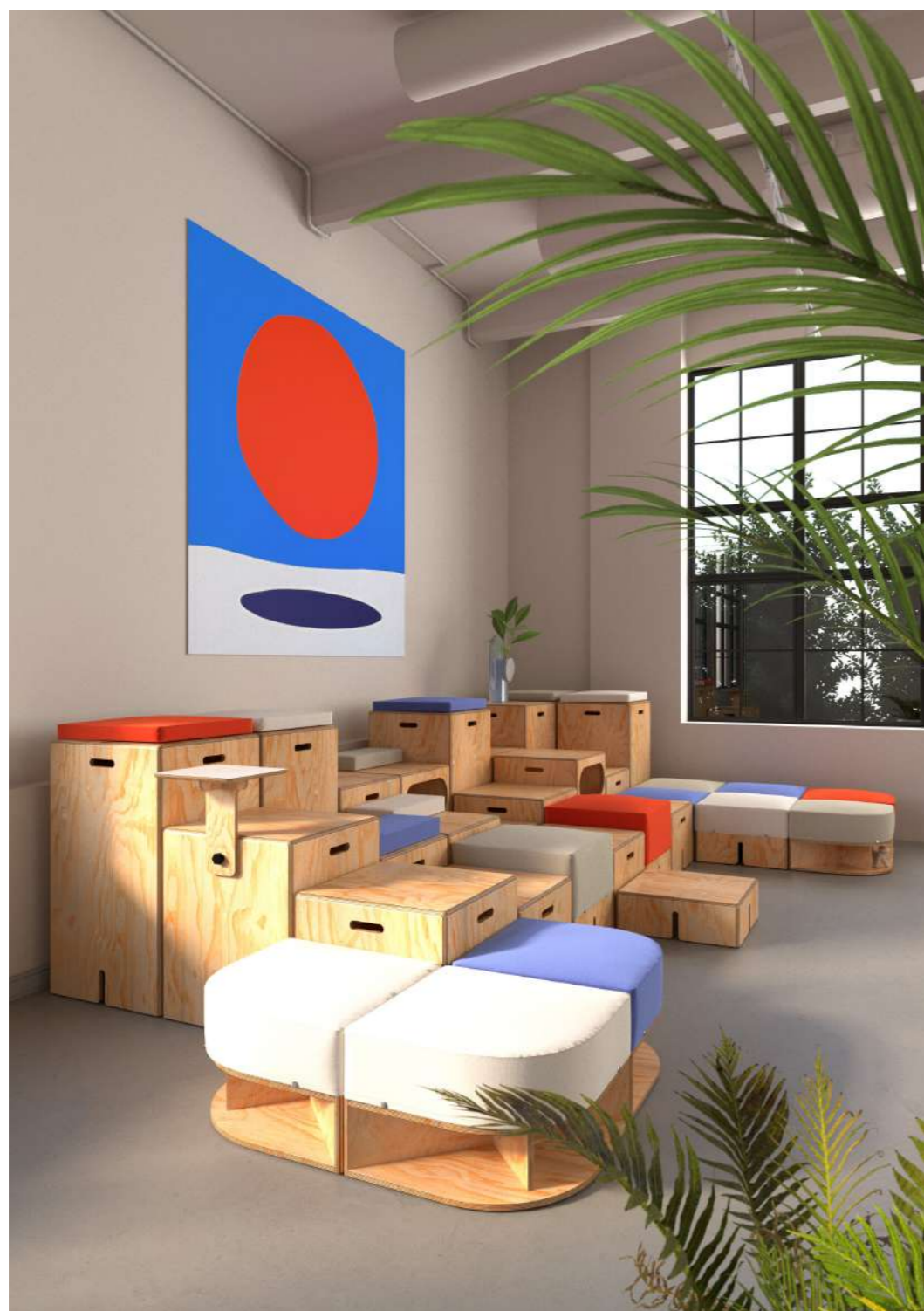

The KEIGIO® 54x54 System is a versatile solution that can be used as a unique workspace, a cosy chill-out zone, an auditorium or a playground.

## KEIGIO® 54x54 SYSTEM Office & School

One of the features of the **KEIGIO® 54x54** System is the mix between rigid and soft elements. This combination creates furnitures that seamlessly blend into any environment, from a cozy living room to a modern office space.

The **WOODEN** elements add a touch of elegance and sophistication, while the **SOFA PUFF** modules provide a comfortable and relaxed seating experience to the composition.

With all the 12 modules, 2 Cushions, and the **SIDE TABLE**, it caters to all needs and spaces. The various heights, material and special variants, add unique features to the system, allowing for endless possibilities.

Whether for cozy seating or functional workstations, the **KEIGIO® 54x54** System offers versatility and adaptability. Unleash your creativity and explore the countless ways to use and enjoy the **KEIGIO® 54x54**.









KEIGIO® 2025

**KEIGIO® 54X54 LOCKER**



# KEIGIO® LOCKER 54X54 SYSTEM

## The new Lockers of the KEIGIO® 54x54 Modular System

KEIGIO® expands its innovative modular furniture system with the new Lockers, designed to integrate seamlessly into the **54x54 SYSTEM**.

While modularity is standard in the lockers market, our products go beyond by integrating into a **complete modular ecosystem**.

The **KEIGIO® 54x54 SYSTEM** brings together rigid seating, Puffs, DESKs, and now the new Lockers, offering a **Flex&Fun** furnishing solution for projects in offices, schools, hotels, libraries, and any space—whether it's a communal area, a service zone, an operational **workspace**, or even rest and recreational areas.

### INNOVATION & PERSONALIZATION

**KEIGIO® LOCKER** is equipped with a **wireless locking system**, efficient and secure.

For further **personalization**, we offer custom stickers with numbers or letters, making it easier to identify the lockers and adding a distinctive design touch.

Additionally, all our products are made from **premium certified materials**.

#MODULARLOCKER #FLEXOFFICE #MODULARDESIGN #KEIGIODESIGN

## THE ELEMENTS

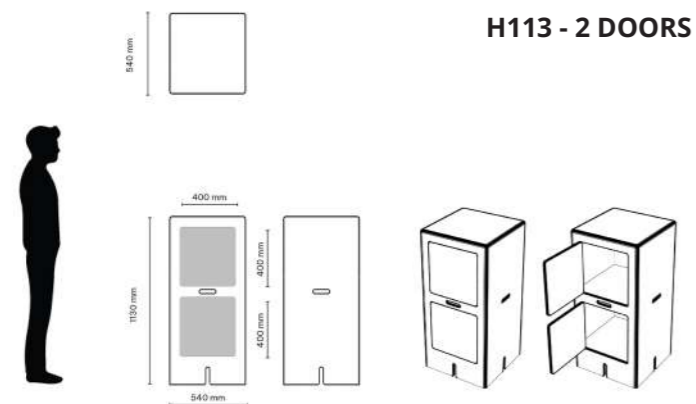
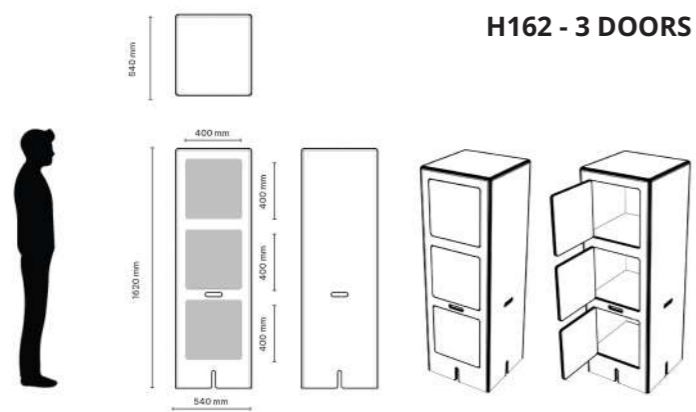
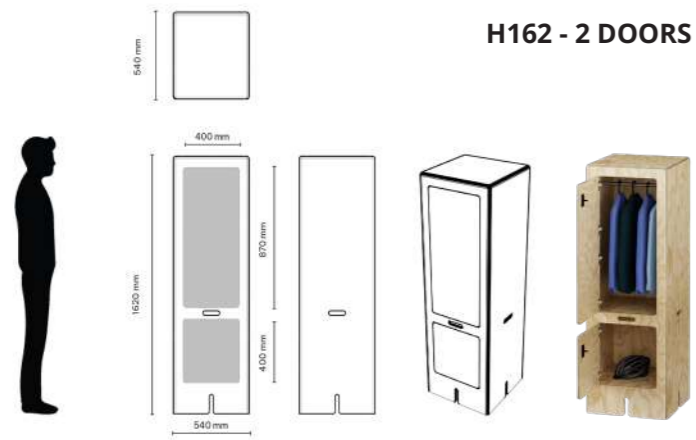

### DIMENSIONS & VERSIONS

With a standard base of 54x54 cm, these lockers are available in two heights: **162 cm and 113 cm**, adapting to the needs of any modern workspace.

The 162 cm version also comes in two variations, with two or three doors. In the two-door variant, the taller door space is perfect for hanging clothes, offering a versatile solution for storing personal items and garments.

### HIGH-QUALITY MATERIALS AND CUSTOMIZABLE DESIGN

**KEIGIO® LOCKER** can be lacquered in any color, maintaining the brand's elegant style, with rounded edges and our signature handles cut on all four sides.

We also introduce a new **Entry Level** material option at an unbeatable price: MDF laminated with white melamine.

**KEIGIO® 54X54 DESK**





## KEIGIO® 54x54 DESK Flexibility and Style in Your Work or Study Space

The KEIGIO® 54x54 modular system offers absolute freedom to create personalized compositions, complementing your work or study environment with versatility and style.

The KEIGIO DESK is modular, consisting of various elements: the structure is composed of our special wood modules or special iron legs, all combined with the DESK TOP, allowing for flexible space distribution and great stability.

The special modules are available with lateral or frontal openings for storage and, like the DESK TOP, are made from high-quality materials such as marine plywood, lacquered RAL MDF, or laminated HPL MDF.

The iron legs, which can be screwed onto the table top, are available in different finishes: white, black, gray, chrome, and stainless steel effect. Additionally, the legs are also available in a version with wheels and brakes.

With the introduction of the new "special" modules and the table top, the modular system offers innovative solutions for a wide range of environments, allowing for the creation of highly functional and customizable workstations.

The 54x54 system easily transitions from a relaxation area to an operational area, perfectly adapting to your needs.

### THE ELEMENTS

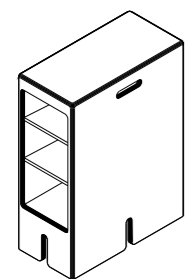

h72 Front HOLE

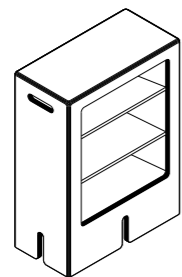

h72 Side HOLE

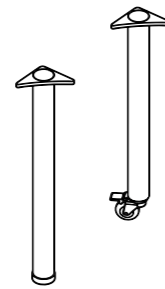

DESK LEGS

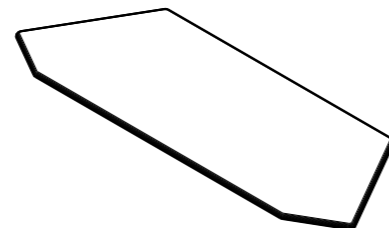

DESK TOP



### CORE DESK DIMENSIONS & MODULARITY

#### Standard Model (165x59 cm):

- Compatible with **54x27 Special Modules** for enhanced customization (replacing standard metal legs with functional modules).
- **Ideal for compact spaces while maintaining utility.**

#### Deep Model (165x65 cm):

- Increased depth to accommodate multi-screen setups, monitor arms, and sound-absorbing divider panels.
- Optimized for ergonomic comfort and spatial efficiency.

### Customizable Sizes for Educational Use

Multiple desk sizes available for school environments, tailored to:

- Student age groups (for example younger vs. older pupils)
- Classroom dimensions (adjusting desk size to fit room layouts).

### Adjustable Height Range

Desk height can be customized from 50 cm to 95 cm, catering to: Ergonomics for seated or standing work and student age groups but also user preferences or accessibility requirements.

## Craft your Composition

The KEIGIO® 54x54 modular system offers complete freedom to create personalized work or study environments. With modular wood elements and customizable desk tops made from high-quality materials, it provides stable configurations and innovative solutions for diverse settings.

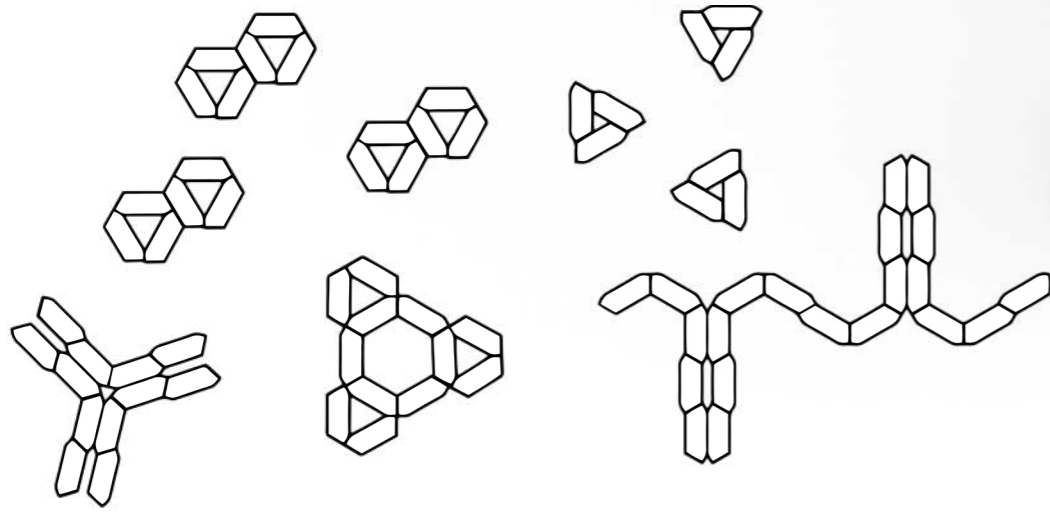
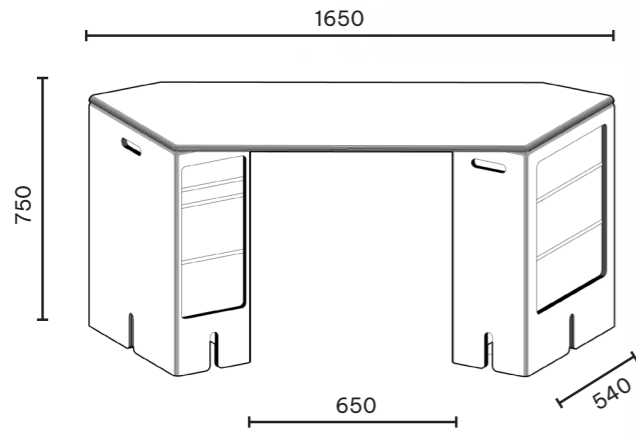

# KEIGIO® PONG





**PING PONG**

Passion for PING PONG grew during the year 2020-21 due to the strict restrictions upon the new form of social life that we were catapulted in. The interest in city parks bloomed and the center of attention of the many people who flocked to it shifted to its sports facilities.

**KEIGIO® HAS RE-INVENTED THE TABLE,  
LET THE GAME ENTER A WHOLE NEW LEVEL.**

*KEIGIO® PONG brings a fresh touch of innovation to this popular vintage game with an easy foldable design!*

Enhance your space with **KEIGIO® PONG** – a sleek and adaptable table that seamlessly converts into a professional-grade ping pong surface.

Designed to accommodate up to 12 people, it optimizes space utilization while maintaining its minimalist appeal. Experience the perfect combination of practicality and style with **KEIGIO PONG**, elevating your living space to new levels of versatility.

Crafted with precision and durability in mind, **KEIGIO® PONG** effortlessly blends into any interior décor, making it a stylish addition to your home or office. Whether you're hosting dinner parties or engaging in intense ping pong matches, this multifunctional table adapts to your needs, ensuring a seamless transition between work and play.

<https://keigio.com/pong/>



#PINGPONGTABLE #KEIGIOPONG #DESIGNTABLE #KEIGIODESIGN



/1

/3



/2



### 1. DETAILS

At **KEIGIO® Design** we have a weakness for details. We have designed ad-hoc graphics for this table and applied them with the technique of **Screen Printing** on wood.

Graphics are different and totally customizable.

We inserted Longboard Skateboard wheels on the legs of the table which becomes way more easily transportable.

### 2. DESIGN

For the first time in the market of these gaming tables we can choose whether to use the table folded and therefore occupying half the space or open.

The measures of the table, are those of an **Official PING PONG** table 152.5x274x76 cm.

### 3. MATERIALS

The **KEIGIO® PONG** is built using noble materials, thick birch or pine plywood a high performance and construction material.

The net is made of transparent fluorescent methacrylate.

All the edges built in plywood are rounded and generate the typical design of all **KEIGIO®** products.

# CUSTOMIZABLE



# KEIGIO® SHELF



## 9 FRAMES

All **KEIGIO® SHELF** is a Freestanding System without the need to be attached to the wall.

**Module Frame Size:**  
52x52x52 cm

#SHELFSYSTEM #MODULARDESIGN #KEIGIOSHELF #KEIGIODESIGN

### **KEIGIO® SHELF is a Configurable Modular System to meet your personal requirements.**

---

The **KEIGIO® SHELF** system is renowned for its adaptability to various spaces and needs. It offers an infinite number of configurations, allowing users to customize it according to their preferences. The shelf elements' joints and arms are constructed from molded raw aluminum, ensuring durability and stability.

What sets the **KEIGIO® SHELF** system apart is its intuitive assembly process. No additional tools are required to assemble the modules, which can be easily arranged in different sizes and configurations. This user-friendly feature makes it convenient for users to adjust the shelves according to their changing requirements.

To enhance its visual appeal, the **KEIGIO® SHELF** system provides a choice of surface materials. Users can select from stainless steel, security glass, or transparent methacrylate to suit their aesthetic preferences. This versatility allows the shelves to seamlessly integrate into any space, be it a home, office, or retail environment.



# KEIGIO® SHELF



/1



/2

/3



### 1. INDUSTRIAL DESIGN

The **KEIGIO® SHELF** system is designed to define and organize the spaces we live in.

The construction elements are minimalist forms that are combined to create horizontal and vertical surfaces that respond to different functional demands for the rationalization of the environments.

### 2. MODULAR SHELF

**KEIGIO®** shelving system is composed of 3 elements: joint, arms (made of die-cast aluminum with precision joints) and shelf, tempered glass or colored methacrylate shelves that fit perfectly into special grooves in the inner arms.

### 3. PERFECT FRACTAL

The shelf system has an almost infinite number of configurations based on perfect proportions like those of a cube that is multiplied to give life to a fractal furniture.

**KEIGIO® SHELF** configurations are freestanding without the need to be connected to the wall.



<https://keigio.com>

MODULAR FRAME: 52x52x52 cm

# KEIGIO® TABLE





## "DIN A" PROPORTIONS

KEIGIO® TABLE sizes are all based on a single aspect ratio of the square root of 2, or approximately 1:1.41421. As the DIN A4 standard sizes share the same aspect ratio ( $\sqrt{2}$ ). Open and Closed Table keep the same proportions.

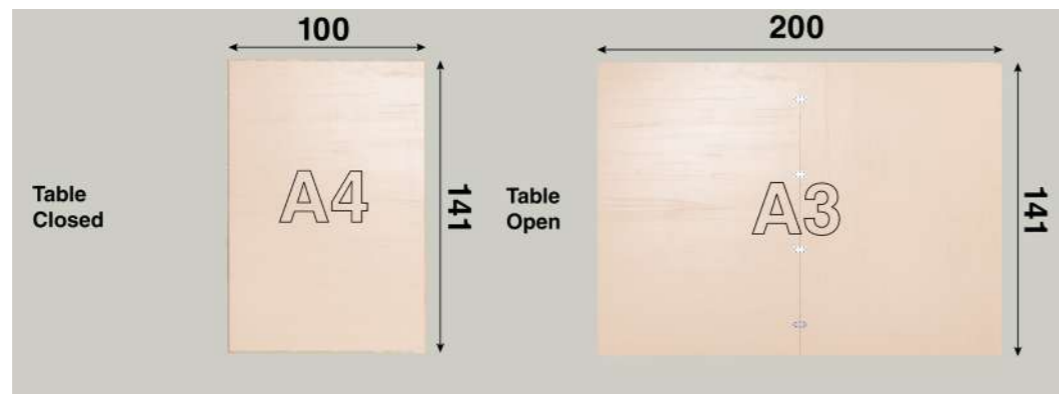

#FOLDINGTABLE #SMARTTABLE #SKATEBOARDFURNITURE #KEIGIODESIGN

### KEIGIO® TABLE, THE A4 PAPER PROPORTION TABLE WITH A SKATEBOARD SOUL.

The **KEIGIO® TABLE** is a carefully designed solution that addresses both our aesthetic preferences and space limitations.

It offers the flexibility to adjust its size effortlessly, transitioning from a **100x141** centimeter configuration that comfortably accommodates 6 people to a larger **141x200** centimeter setup that can seat 10 diners. The table is equipped with big longboard wheels, from the american brand **Orangatang**, making it very easy to move within your space.

The table is crafted from high-quality birch or pine plywood and **Lisocore®** - a high-performance construction material.

Its sizes are based on a single aspect ratio of the square root of 2 (approximately 1:1.41421), which harmonizes with **DIN A4** standard sizes. Whether the table is open or closed, it maintains consistent proportions, ensuring visual harmony.

# KEIGIO® TABLE



2025 COLLECTION

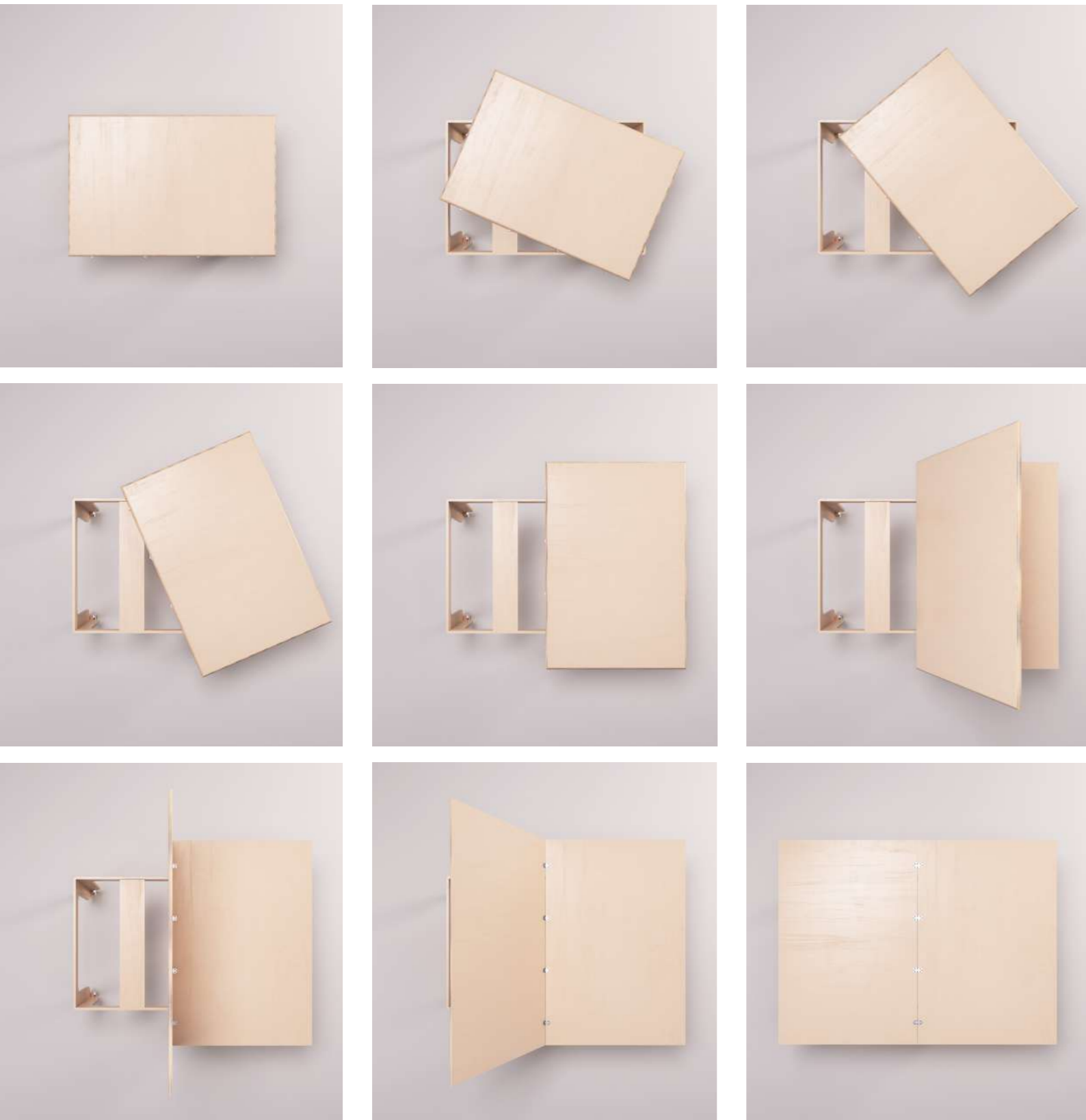

## CUSTOMIZABLE DESIGN

We design ad-hoc graphics for this table and applied them with the technique of **Screen Printing** on wood. Graphics are different and totally customizable.

## FOLDING SYSTEM

**KEIGIO® TABLE** transforms its size from 100x141 to 141x200 centimeters with one simple 90 degrees rotation that magically keeps the table perfectly centered with the table legs.

After rotating, we can open the tabletop like a book, thus doubling the size of our table.

**OPEN: 141x200x76 cm CLOSED: 100x141x76 cm**



All the edges built in plywood are rounded, typical design of all KEIGIO® products.

/ 1



/ 3



/ 2

### 1. DETAILS

At **KEIGIO®** design we have a weakness for details.

Foldable **KEIGIO® TABLE** is characterized by clean lines and soft shapes with the unmistakable style of our products.

We inserted Longboard Skateboard wheels on the legs of the table which becomes more easily transportable.

### 2. DESIGN

Foldable **KEIGIO® TABLE** measures are 141x200x76cm Open and 100x141x76 cm Closed.

**KEIGIO® TABLE** sizes are all based on a single aspect ratio of the square root of 2, or approximately 1:1,41421.

As the DIN A4 standards sizes share the same aspect ratio.

Open and Closed Table keep the **same proportions.**

### 3. MATERIALS

The **KEIGIO® TABLE** is built using noble materials as **FSC** (Forest Stewardship Council) certified natural birch or pine plywood, and **Lisocore®** that is a material-efficient high performance construction material.

This modern material achieves its excellent properties thanks to its unique structure.



**KEIGIO® CHAIR**

## ORANGATANG

Our stunning Durian 75mm Longboard Wheels by the Californian brand Orangatang in 3 different colors

#CHAIRS #SKATEBOARD #WHEELEDCHAIR #PLYWOODDESIGN



# SKATEBOARD CHAIRS

The **KEIGIO® CHAIR** is completely handmade, with care and every little detail is inspired by the passion for Skate.

The **KEIGIO® CHAIR** is an element with an innovative design characterized by clean lines and soft shapes with the unmistakable style of our products.

The **KEIGIO® CHAIR** are surmounted by a 60mm diameter tubular galvanized iron backrest that recalls the structures of the skateparks and is comfortable and enveloping.

The chairs are available in two variants, with and without large Longboard wheels. The clear reference to the world of skateboarding is the result of the fusion of different passions such as design and urban culture, both part of our DNA.

# KEIGIO® CHAIR

2025 COLLECTION

<https://keigio.com/chair/>



The skateboard wheels allow excellent stability and smooth movement in the room.



**KEIGIO® CHAIR** is surprisingly sturdy and has a very comfortable slide-grind rail style backrest. It is equipped with huge 75mm diameter Longboard wheels from the famous American brand **Orangatang** which make it very easy to move and is equipped with brakes to stabilize in one position.

Our chairs perfectly match the tables we have designed, same arches, same rounded edges, same concept. It is made with **FSC certified wood** materials, the most reliable sustainable forest solution in the world. The type of wood used is natural marine birch or pine plywood which makes it very strong and resistant.

Two elements in 3D printed plastic material complete the armrests of the backrest. They will be branded with the K of **KEIGIO®** on one side and with the lightning bolt on the other but you could choose to customize them as you wish.

# KEIGIO® STOOL





## KEIGIO® BAR

Counter bar built by KEIGIO® in premium Fenix material from the Italian brand ARPA Industriale.

Stool Height: 80 cm

#BARSTOOLS #COUNTERSTOOLS #KEIGIOSTOOL #PLYWOODDESIGN

# BAR & COUNTER STOOLS

**The KEIGIO® STOOL comes in different customizable heights and can be used as either a counter stool, a bar stool or a high bar stool.**

---

The **KEIGIO® STOOL** uses only wood materials of FSC certified origin and the finishes can be in natural Birch, natural Pine, white or black MDF laquered.

The wood ones are painted with two coats of a highly transparent finish with a satin and natural effect that leaves the highest quality wood face "in sight".

The stool is made of plywood, which, thanks to the layers of ultra-stistant varnish, gives it a perfect resistance to moisture, making it particularly hard and robust and suitable for any type of bar, restaurant and commercial space.

2025 COLLECTION



# KEIGIO® STOOL



The KEIGIO® STOOL comes in four different heights - 80cm, 70cm, 60cm, and 48cm - allowing you to choose the perfect height for your needs.

The seat is always a comfortable 36cm x 36cm, providing ample space for seating.

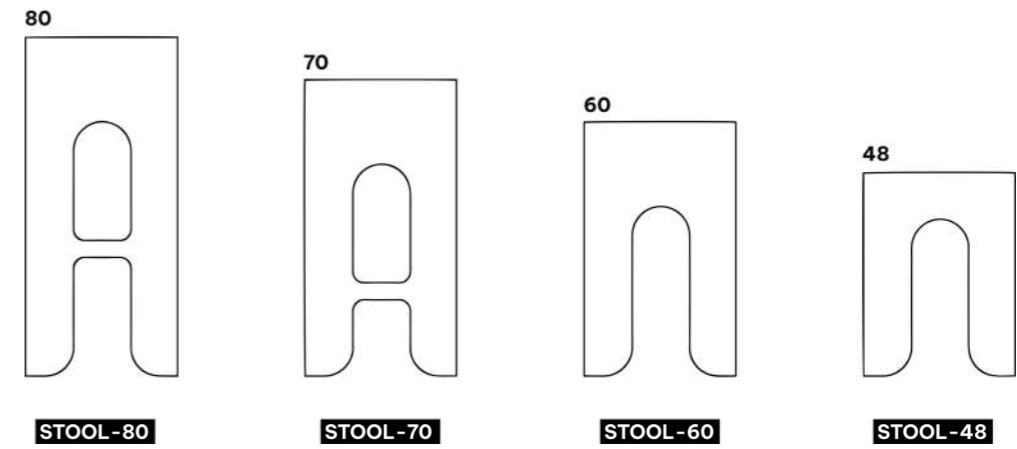



**KEIGIO® LAMP**

24 MODULES:  
9 OPEN TRANSPARENT  
3 OPAL WHITE LAMP  
11 CLOSED LIGHT BLUE  
1 CLOSED NEON RED

**The translucent methacrylate KEIGIO® LAMP system composed of 3 different modules: open, closed or illuminated. They are easily configurable to obtain a number of different lamp shapes.**

The **KEIGIO® LAMP** system is inspired by the 80s game, the Rubik's Snake, and we have scaled it to get a completely modular lamp.

The translucent methacrylate elements can be open, closed and illuminated modules easily configurable in order to obtain an infinite number of shapes.

The lamp is transformable in a playful way to resemble a wide variety of objects, animals, or geometric shapes like the original toy.

#LAMPSYSTEM #MODULARDESIGN #KEIGIOLAMP #KEIGIODESIGN



2025 COLLECTION

# KEIGIO® LAMP

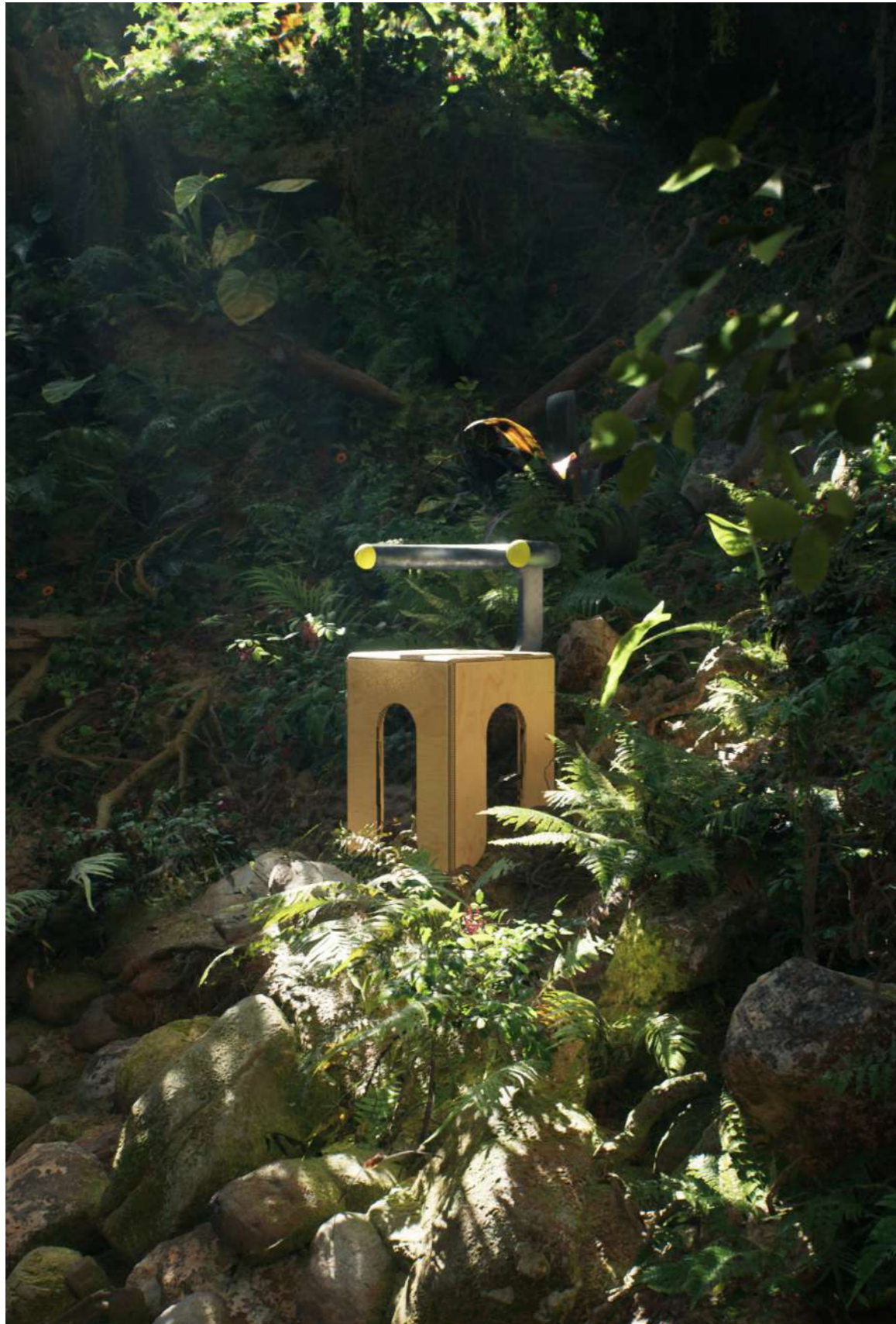

## Advantages of Environmental Sustainability in Using Modular Furniture

**Reduced Resource Waste:** KEIGIO® modular furniture is designed to be easily assembled, disassembled, and transported. This means they can be repositioned or reused in different environments without needing to be replaced, thus reducing the consumption of natural resources and the disposal of furniture in good condition.

**Waste Reduction:** Modularity minimizes material waste during production. KEIGIO® modular furniture is made from sustainable and recyclable materials such as FSC-certified wood, recyclable plastic, and fabrics produced from recycled materials.

**Adaptability:** The flexibility of KEIGIO® modular furniture allows spaces to be adapted to specific needs, reducing the need for demolishing and building new structures. This can reduce the environmental impact associated with construction and space renovation.

**Extended Lifecycle:** Due to the ability for repositioning and reuse, KEIGIO® modular furniture tends to have a longer lifecycle compared to traditional furniture. This means they can remain in use for longer before needing replacement, thus reducing the overall amount of waste to be disposed of.

**Sustainable Production:** By utilizing recycled or completely recyclable materials, KEIGIO® aims to create a sustainable production cycle. This commitment to using eco-friendly materials helps minimize the environmental footprint of our furniture and supports a circular economy.

In summary, the use of KEIGIO® modular furniture can significantly contribute to promoting environmental sustainability in work environments, reducing the overall environmental impact and promoting more efficient use of resources.



## SHOWROOM

Since 2018, you can visit our KEIGIO® showroom in the heart of Barcelona's downtown.

---

*Our furniture is presented amongst a retro-futuristic industrial decoration reflecting our brand.*

*Feel free to visit or contact us to receive our personalized service and more information about KEIGIO® Design.*

### CONTACT

Linkedin: @keigio design  
Instagram: @keigiodesign  
YouTube: Keigio Design

info@keigio.com  
+34-628 009 371

### ADDRESS

Carrer Gombau, 18  
08003 Barcelona.

Parking available at  
Santa Caterina Market.

### OPENING HOURS

Monday to Saturday  
10:30 am - 6:30 pm.

<https://keigio.com/showroom/>

CORPORATE VIDEO: <https://youtu.be/cd8vCgSXuGM>



If KEIGIO® were a music band, it would identify with the “indie music” scene. In the world of music, the term “indie”, comes from “independent”, and here it describes small and relatively low-budget labels and the do-it-yourself attitude of the artists involved.

### Environmental Commitment and Eco-Contribution by KEIGIO® DESIGN

KEIGIO® DESIGN is committed to environmental sustainability with FSC® certified materials, modular design, digital catalogs to reduce paper consumption, Oeko-tex® and Euflower-Ecolabel® certified fabrics, and collaborates with Valdelia®, specifically in France for responsible furniture waste disposal, we also have or we are continuing searching for other partners across the rest of Europe.



The colours, finishing, illustrations and descriptions in this catalogue are provided solely by way of example. KEIGIO®, if necessary and in order not to stop the continuous improvement process and updating of the technical production, reserves the rights to change its models, without giving prior notice, improving them with all the technical and structural modifications as considered appropriate.

We are member of:



Events and trade shows we have participated in:





CHAIR

LAMP

SHELF

SOFA

TABLE

## CONTACT

Linkedin: @keigio design  
Instagram: @keigiodesign  
YouTube: Keigio Design

info@keigio.com  
+34 628 009 371

## ADDRESS

Carrer Gombau, 18  
08003 Barcelona.

Parking available at  
Santa Caterina Market.

## OPENING HOURS

Monday to Saturday  
10:30 am - 6:30 pm.

[www.keigio.com](http://www.keigio.com)